

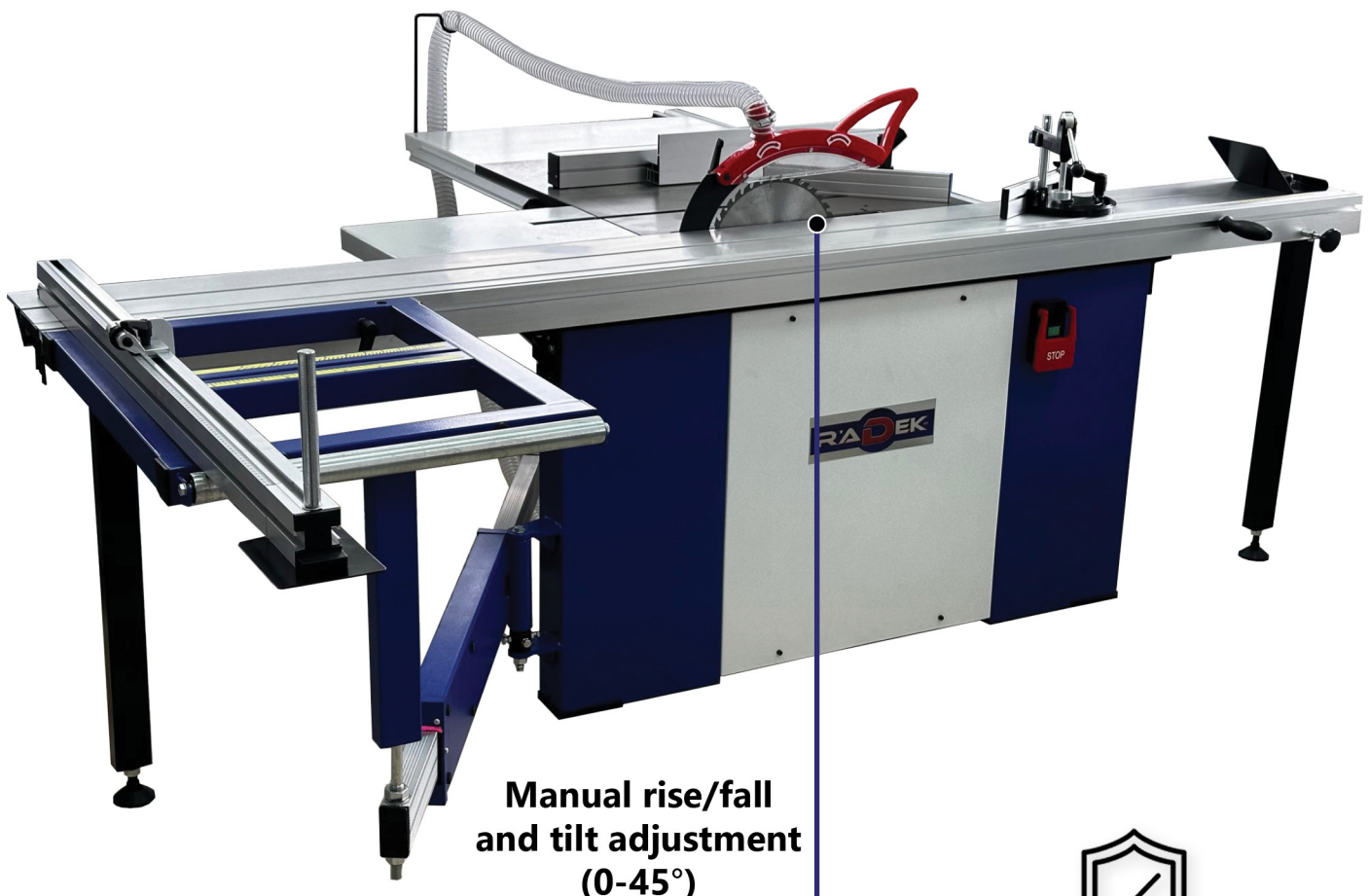

**RK-2800-ECO**

# SLIDING TABLE SAW

PERFECT MACHINE FOR BOTH PROFESSIONAL  
AND AMATEUR CARPENTERS



**Manual rise/fall  
and tilt adjustment  
(0-45°)**

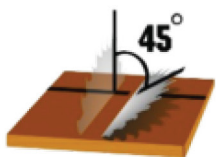

**1 YEAR WARRANTY  
AND UNLIMITED SUPPORT**

Motor power	3kW
Dimensions of a large table	385×800mm
Extension table (cast iron)	440×800mm
Extension table (steel plate)	440×800mm
Rear extension table	310×500mm
Sliding table size	2800 × 270mm (optional - 3200x270)
Dimensions of supporting table	680×580mm
Fence	1200-2200mm
Size of main saw	315×30×3mm
Large saw speed	4000rpm
Size of a small saw	90×20×3mm
Small saw speed	5800rpm
Maximum cutting depth	100mm at 90°(315), 80mm at 45°(315)
Max. Distance from knife to fence	1220mm
Maximum cutting length	2800mm
Maximum cutting width	1350mm
Packaging dimensions	1600×765×1050mm / 2860x250x320mm
Machine size	2800x2900x870mm
Weight	350kg



A format saw with a scoring saw for processing high-density boards, MDF boards, ABS panels, PVC, solid wood and other materials based on wood or with a similar structure and hardness. The machine is built on a welded steel body with a cast iron fixed table and an aluminum movable table made of profiled aluminum with increased durability. The perfect machine for both professionals and amateur carpenters.

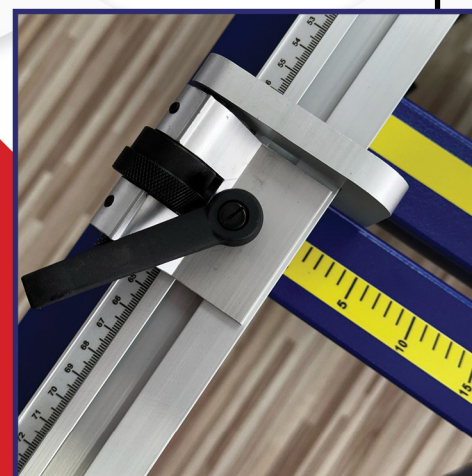



DETAILS

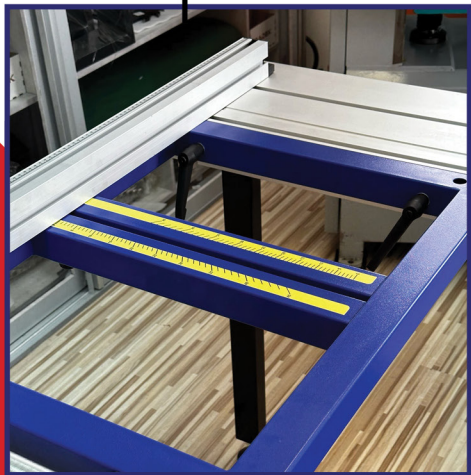
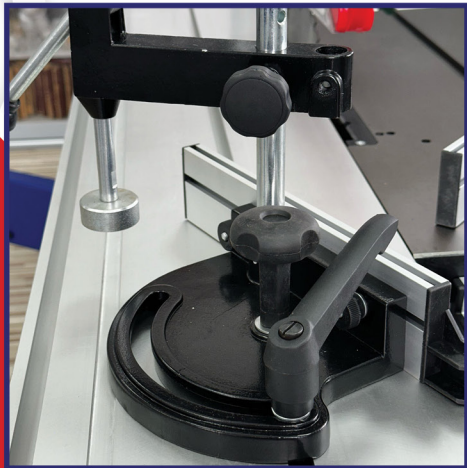
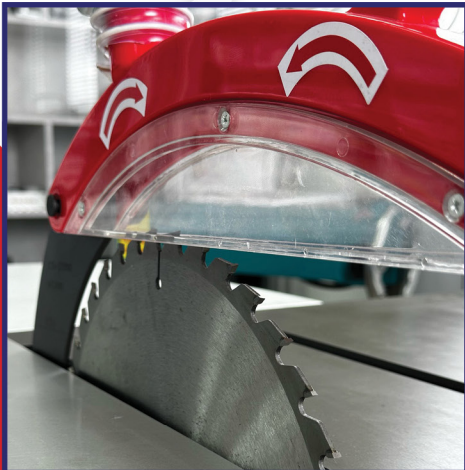
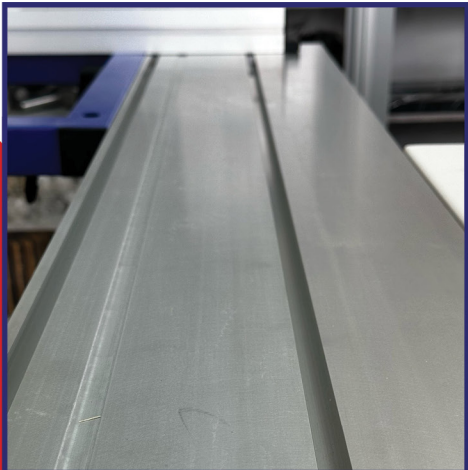

# DETAILS

## ● Two cutting discs

The saw is equipped with two cutting discs - the main one and the undercut one, which provides great possibilities for cutting various types of wooden materials.

## ● Large format table

One of the main advantages of this model is an exceptionally large, ball-bearing format table with a support, which enables precise processing of large-format chipboards with a length of up to almost 3000mm and other large wood-like materials.

## ● Additional scoring blade

The additional scoring disc makes the saw perfect for cutting furniture boards and chipboards, eliminating the risk of chipping and ensuring evenness of the cut.

## ● Disc tilt

The cutting disc can be tilted from 90° to 45°, which allows you to make bevels and cuts at various angles.

## ● Maximum guide length

This saw is equipped with an impressive guide length of 2300mm, allowing it to handle large materials and make precise cuts.

## ● Replacing the disc

The replacement process is quick and efficient, thanks to the possibility of dismantling the metal top and unscrewing the disc.

## ● Saw guard

The saw has an effective saw blade guard that can also be connected to an extraction system to help keep your work area clean.

## ● Control panel

The machine's control panel is located at the bottom of the saw and contains an emergency switch, a knob for angle cuts (45°) and a knob for adjusting the height of the blade with a lock.

## ● Useful accessories

The machine includes a polished cast iron top, three extension tops and a ruler with an additional measure for measuring and processing large-surface materials. The upper tabletop is equipped with a material length scale, which makes work easier and helps achieve precise results.

## ● Additional measuring devices

All guides have scales for length and cutting angles, which allows you to quickly set the required angle and length without the need to make additional measurements.

## ● Compatibility with extraction

The saw is designed to be connected to a sawdust and shavings system with a suction nozzle diameter of 100mm, which helps keep the workplace clean.