



CO₂ ЛАСЕР

RK-6040-PRO

РЕЗЕРВНИ ДЕЛОВИ



Y-Axis Stepper Motor

Brand: CVL
 Model: Nema 23 Stepper Motor
 Torque: 0.9N.m
 Rated Current: 2.8A
 Step Angle: 1.8 degrees
 Shaft Diameter: 8mm

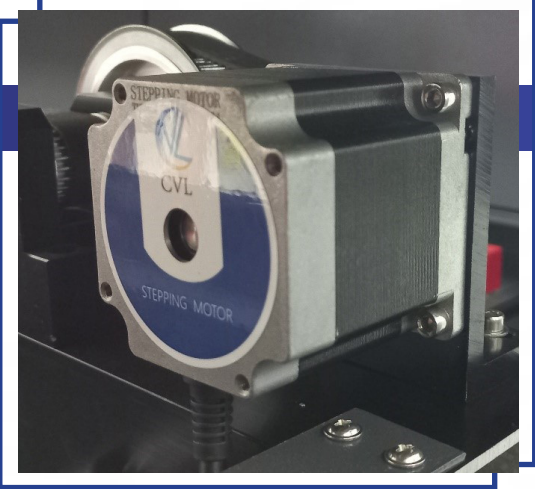

X-Axis Stepper Motor

Brand: CVL
 Model: Nema 23 Stepper Motor
 Torque: 0.9N.m
 Rated Current: 2.8A
 Step Angle: 1.8 degrees
 Shaft Diameter: 8mm

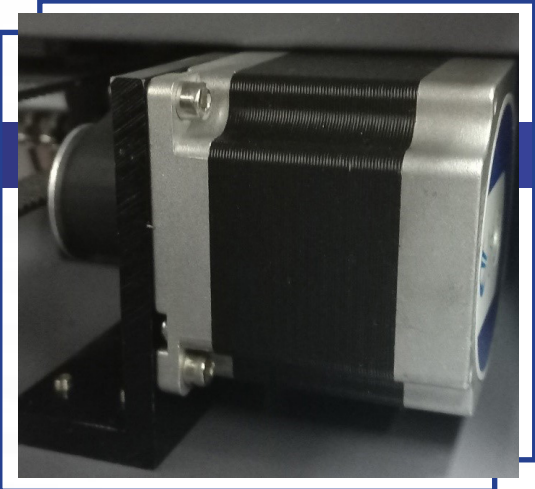

Z-Axis Stepper Motor

Brand: CRL
 Model: Nema 34 Stepper Motor
 Type: 86BYGH400
 Torque: 8.2 N.m
 Current: 6.0A
 Step Angle: 1.8 degrees

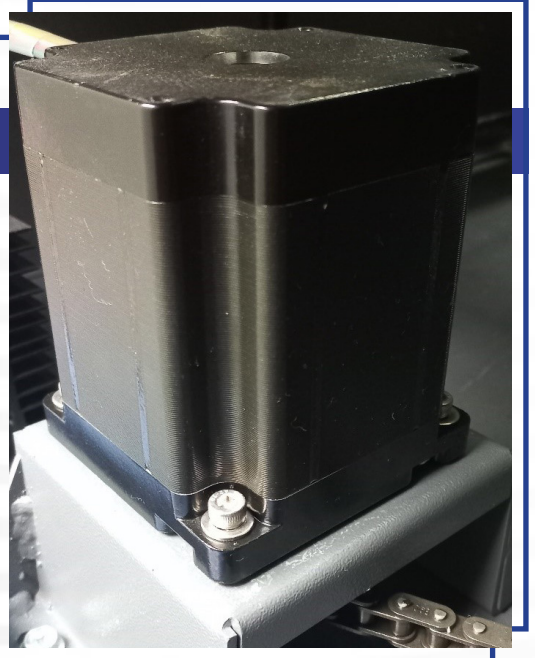

Exhaust Fan

Brand: SVNQN
 Model: FP-108 EX-S1-S
 Power: AC 220V - 50/60Hz - 0.22A - 38W
 Diameter: 150mm



CO2 Laser Power Supply

Brand: ZYE Laser
 Model: MYJG80W
 Input Voltage: AC 220V
 Rated Power: 80W
 Tube Voltage: 24000V



Linear Rails Y-Axis (x2)

Model: HGR15
 Width: 15mm
 Height: 15mm

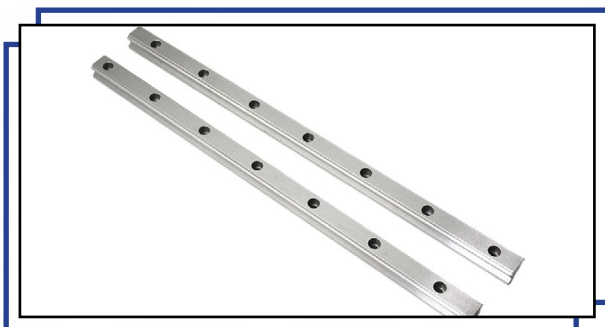

Linear Rails X-Axis

Model: HGR15
 Width: 15mm
 Height: 16mm



**Linear Ball Bearing Block/Carriage
Y-Axis (x2)**

Model: HG15



**Linear Ball Bearing Block/Carriage
X-Axis**

Model: HG15



Power Supply 24V

Brand: Guanyang
 Model: GY250W-24-B
 Input Power: AC 110-220V 50/60Hz
 Output: DC 24V 12A

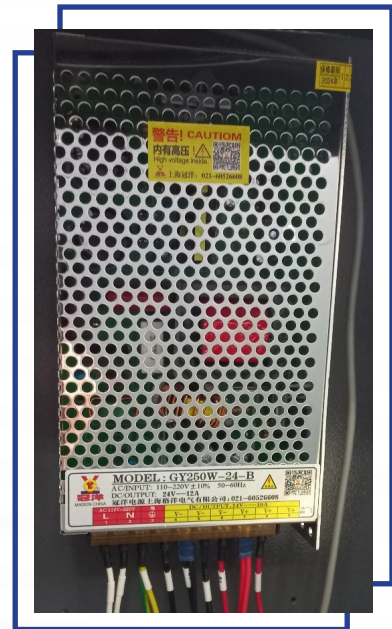
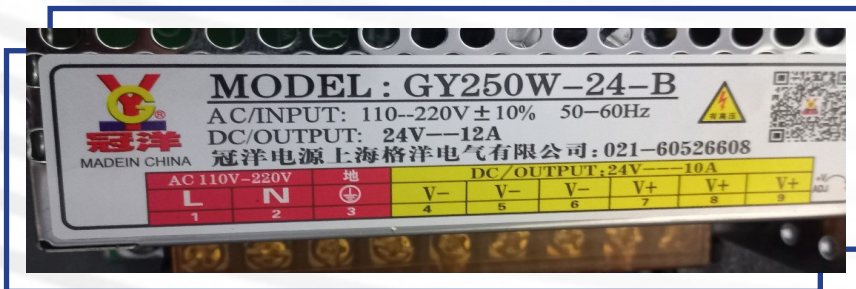

**Stepper Motor Driver (x2) (X-Axis,
Y-Axis) (for Nema23)**

Brand: LeadShine
 Model: Microstep Drive M542C
 Output Current: 1A – 4.2A
 Supply Voltage: AC 20-50V
 Drive Mode: PWM



Controller (Mainboard)

Brand: Ruida
 Model: RDC6445S
 Input Power: DC 24V 2A
 Serial: RDC445082039102

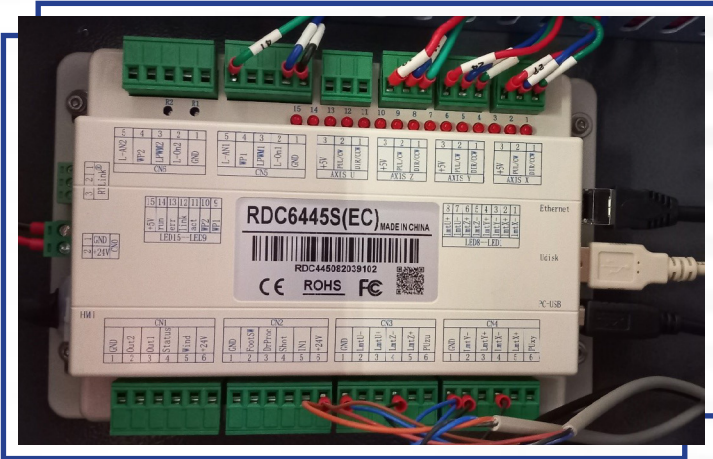

Controller (Display Panel)

Brand: Ruida
 Model: RDC6445S
 Screen Size: 5.0" TFT – 854-480 Resolution ,
 64K Colors
 RS232 Standard Serial Communication



Signal Filter

Brand: Hongda
 Model: HD2AC-10A Power EMI Filter
 Rated Power: AC 110/250V - 10A - 50/60Hz

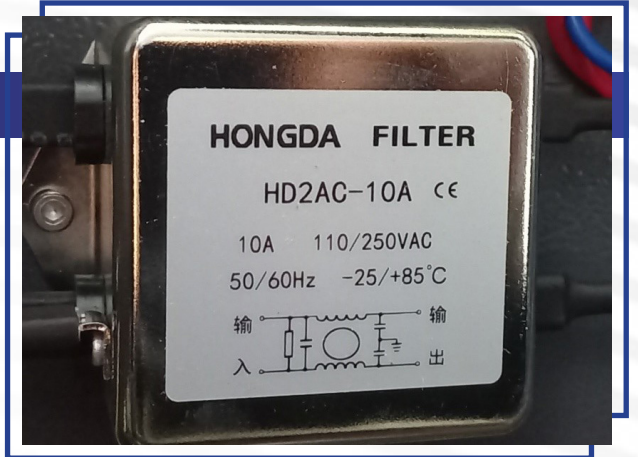

E-Stop Button

Brand: YIJIA
 Model: YJ139-LA38
 UI: 440V
 Ith: 10A



Laser Power Button

Brand: CHLI
 Model: HL-LA38 (LA38, LA39)
 UI: AC 415V
 Ith: 10A
 GB/T 14048.5



Stepper Motor Driver (x1) (Z-Axis, Automatic Focus) (for NEMA34)

Model: 2H Mcrostep Driver DM860H
 Input Current: DC 24-80V Typical Value: DC 36V
 Output Current: 2.4A-7.2A
 Drive Mode: PWM

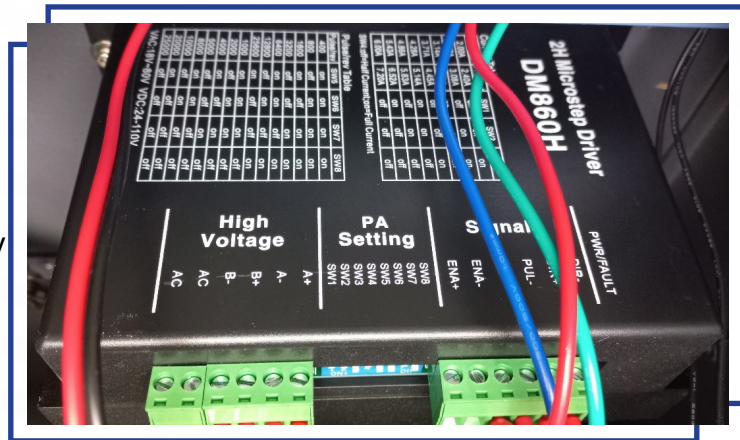

Transmission Belt

Brand: BEIDI
 Model: 3600-3M
 C0402B



Belt Pulley (Large) (x2)

Outer Diameter: 68mm
 Shaft Diameter: 10mm

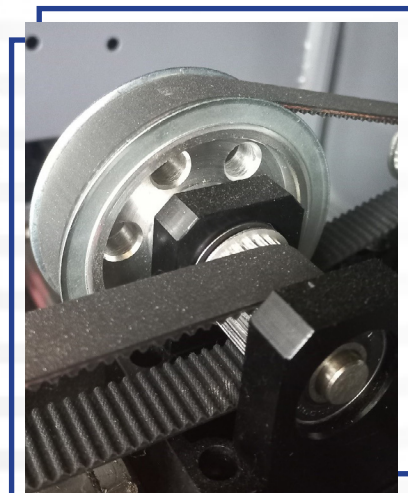

Belt Pulley (Small) (x8)

Outer Diameter: 22mm
 Shaft Diameter: 8mm

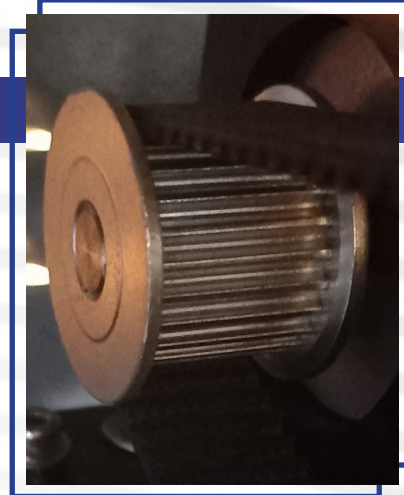

Inductive Proximity Sensor (x2)

Model: PL-05NB
 Sensing Distance: 5mm
 Operating Voltage: DC 10-30V
 Output Method: NPN, 150mA load

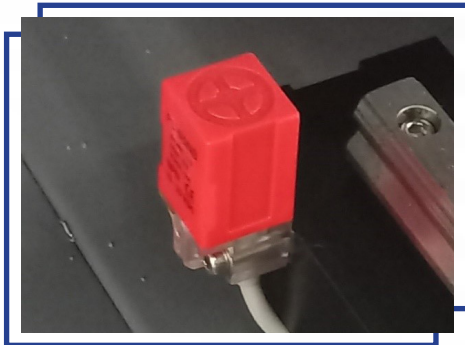

X-Axis Pulley, shaft Bearing

Brand: JVB
 Type: 6000RS
 Bore Diameter: 10mm
 Outer Diameter: 26mm
 Width: 8mm



Y-Axis Pulley, Shaft Bearing

Brand: JVB
 Type: 6000Z
 Bore Diameter: 10mm
 Outer Diameter: 26mm
 Width: 8mm



Drag Chain Cable Organizer (X-Axis)

Height: 15mm
Cable Slot Width: 10mm

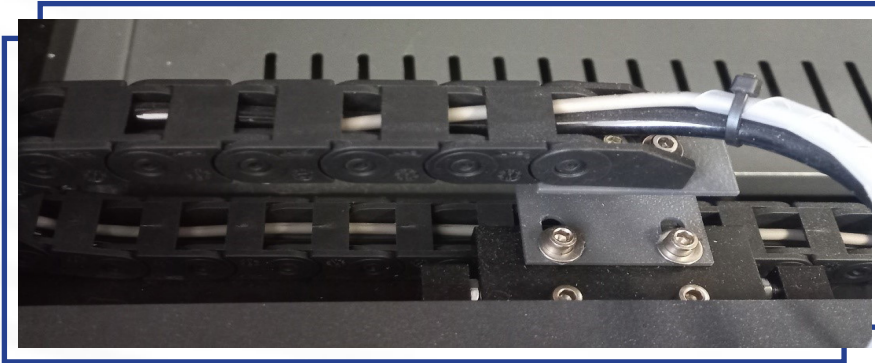

Drag Chain Cable Organizer (Y-Axis)

Height: 20mm
Cable Slot Width: 15mm



DC Analog AMP Meter

Brand: HN
Model: 85C17
Range: 0-50mA

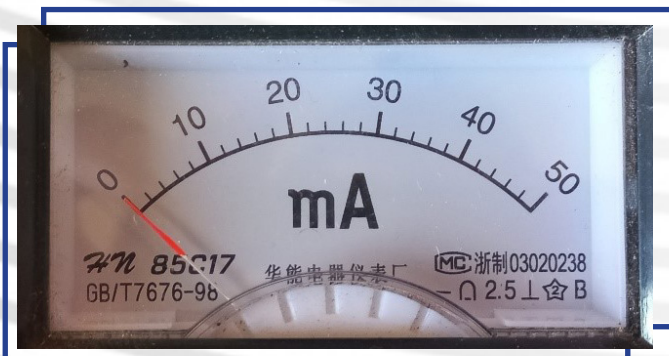

Y-Axis Transmission Shaft

Length: 950mm
 Diameter: 22mm

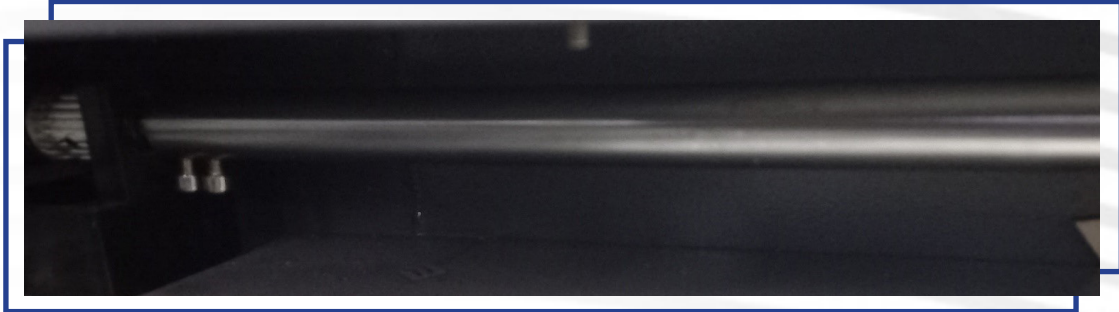

Laser Tube

Brand: RECI
 Output Power: 80W / 100W
 Length: 1250mm / 1450mm
 Diameter: 80mm



Generic Drive Sprocket (x4)



Threaded Rods (x4)

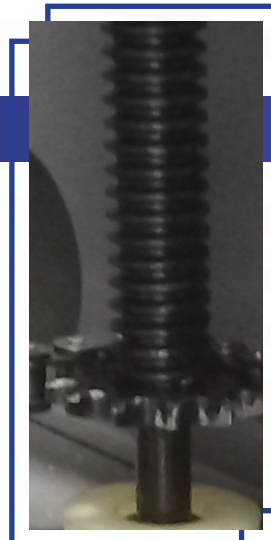

Anti-Shock, Anti-Vibration Leg Stand (x4)

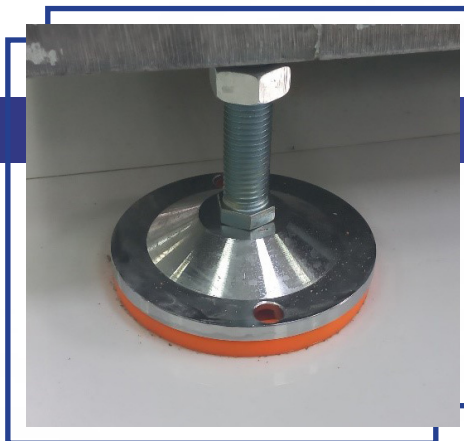

Transport Wheels with locking function



Generic Handle



Generic Pneumatic Support Rod (x2)



Laser Head

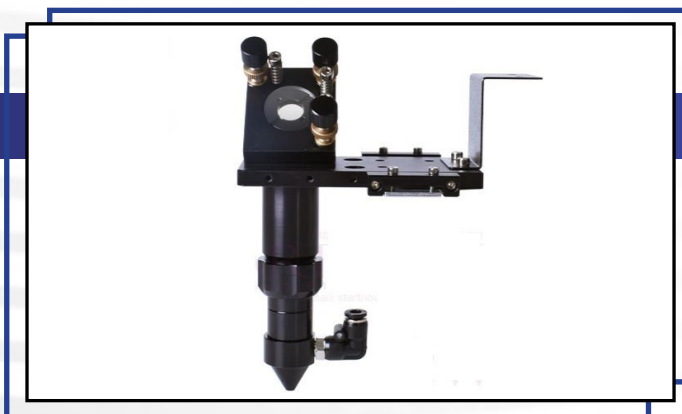

Mirror Mount (x3)

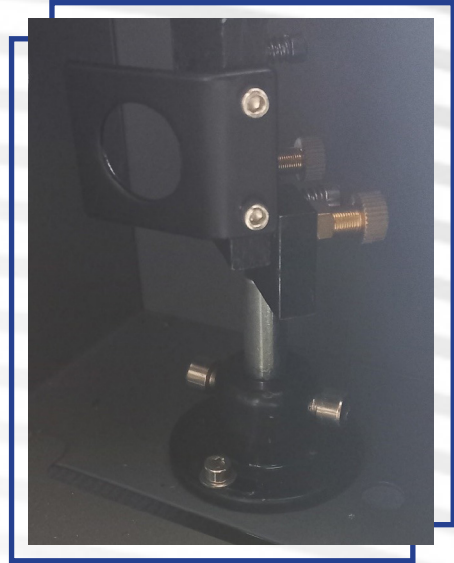
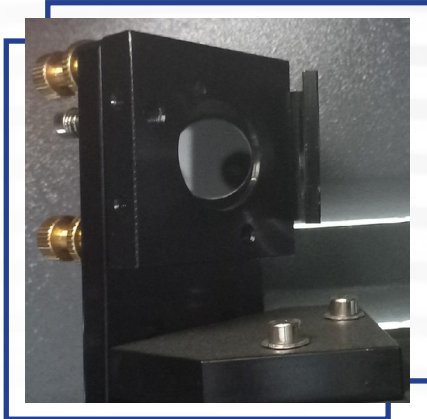

Auto Focus Sensor

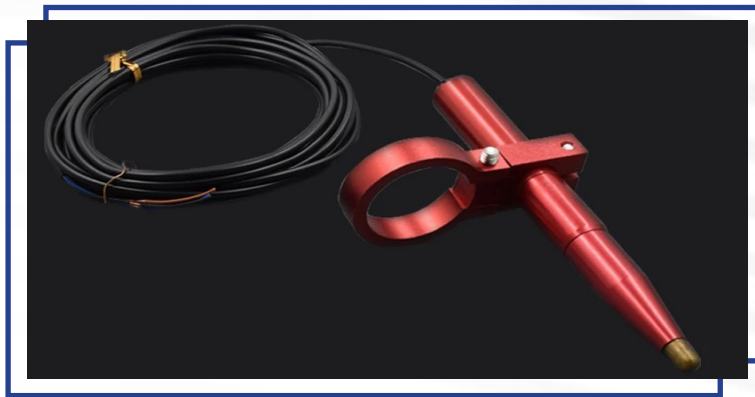

Mirrors (x3)



Focusing Lens



Transmission Chain (Bed Leveling)

Type: 06B



Industrial Chiller

Brand: S&A
 Model: CW-5000TG T-Series Industrial Water Chiller
 Power: AC 1PH 220-240V 50/60Hz 0,4-2,79A
 Tank Capacity: 6L
 Max. Pump Lift: 10m
 Refrigerant: R-134a



Air Compressor

Brand: RESUN
 Model: ACO-004
 Power: AC 220V 50Hz 58W
 Pressure: 0,028MPa
 Flow: 75L/min



Dust/Smoke Extraction Unit

Model: YQ-14880
 Power: AC 220V 50Hz 550W
 RPM: 2800rpm
 Intake Diameter: 148mm
 Exit Diameter: 148mm
 Airflow: 18m³/min
 Static Pressure: 1,7KPa



Rotating Axis

Lathe Chuck Diameter: 80mm
 Stepper Motor: NEMA23
 Model: 23HD450Y-31A11

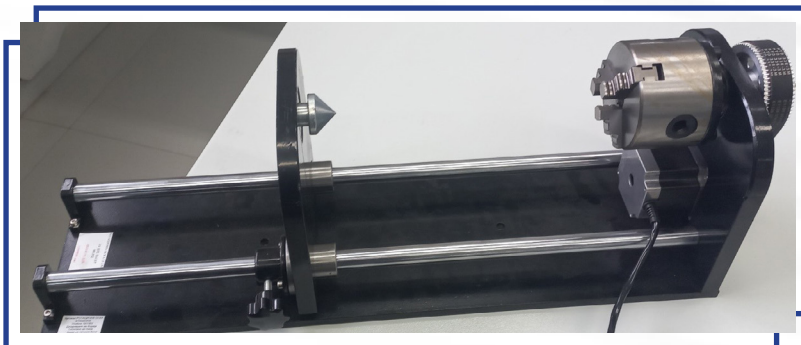
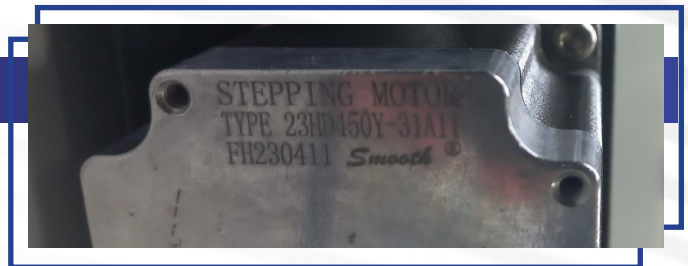

Rotating Axis (Low Profile)

Stepper Motor: NEMA23
 Model: 23HD450Y-31A11

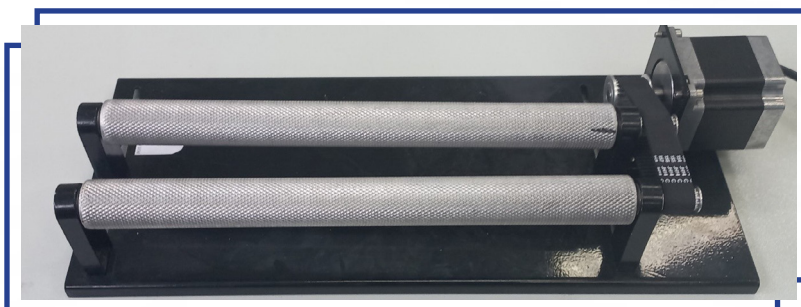



КОНТАКТ

☎ Информации: +389 70 215 994

☎ Продажен салон: 02 3095 002

✂ Сервис: +389 71 270 963

✉ Е-маил: info@radek.com.mk

🌐 Вебсајт: www.radek.com.mk

📍 Адреса: Јадранска Магистрала 716

РАБОТНО ВРЕМЕ

Пон.-Пет.: 09:00-17:00

Саб.: 09:00-14:00



GOOGLE MAPS:
RADEK WOODWORKING
MACHINES



Web

www.radek.com.mk



Facebook

[radek-woodworking machines](https://www.facebook.com/radek-woodworking-machines)



Instagram

[radek_woodworking_machines](https://www.instagram.com/radek_woodworking_machines)



Startuvaj.mk

www.startuvaj.mk



YouTube

[radek woodworking machines](https://www.youtube.com/radek-woodworking-machines)

**WOODWORKING AND
METALWORKING MACHINES**